

BX-2600



B BOX DOCCIA
SHOWER BOX

BX-2600 SET 2 NICCHIA | NICHE | NISCHENDUSCH

- Sistema scorrevole per box doccia pieghevole a soffietto in nicchia.
- System for shower cabin with folding doors for niche.
- System für Duschkabin mit Falldüren für Nische.

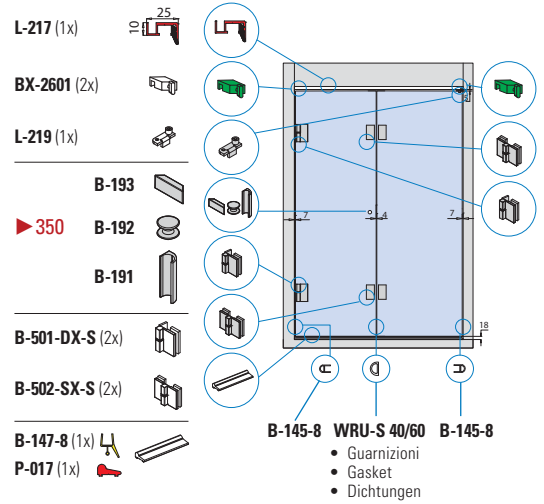

xme300

Profili vetro fisso
Profiles for fixed panels
Profil für Festverglasung.... ▶ 174

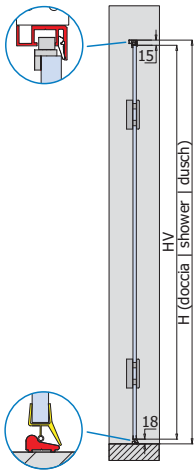

- Indicare sempre il senso di apertura.
- Please specify always opening direction.
- Bitte immer Öffnungsrichtung angeben.

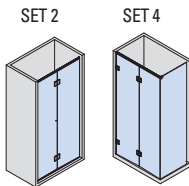
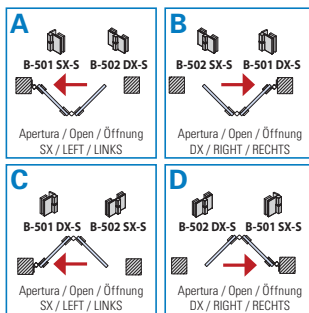

COMPONENTI | COMPONENTS | EINZELTEILE

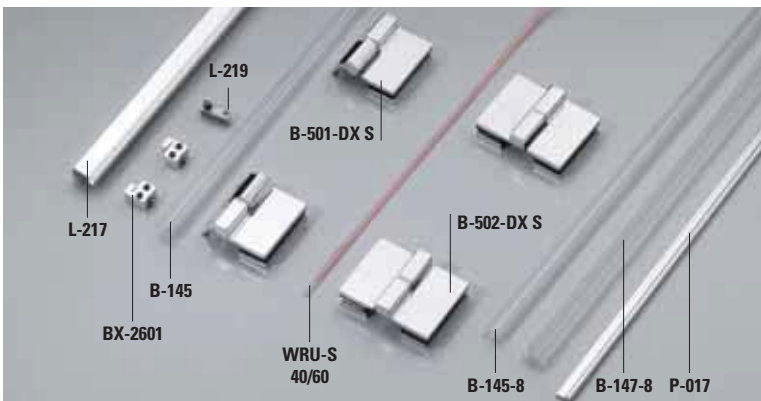

BX-2600 SET 4 SPALLA IN VETRO | 2 FIXED PANELS
2 FESTSTEHENDEN GLASTAFELN

- Sistema scorrevole per box doccia pieghevole a soffietto con spalla in vetro.
- System for shower cabin with folding doors for 1 fixed panel.
- System für Duschkabin mit Falldüren und 1 Seitenteil.

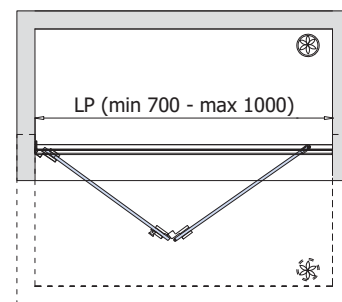
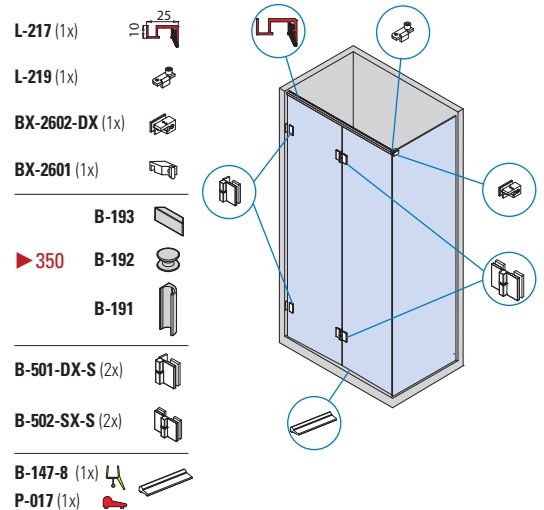

xme359

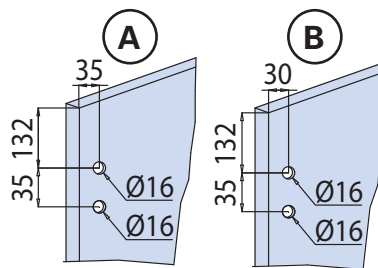
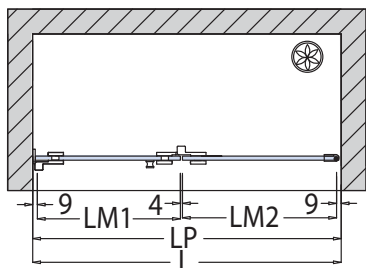
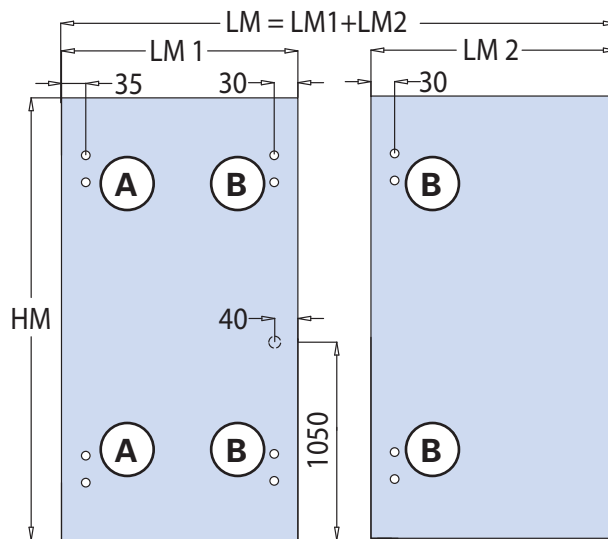
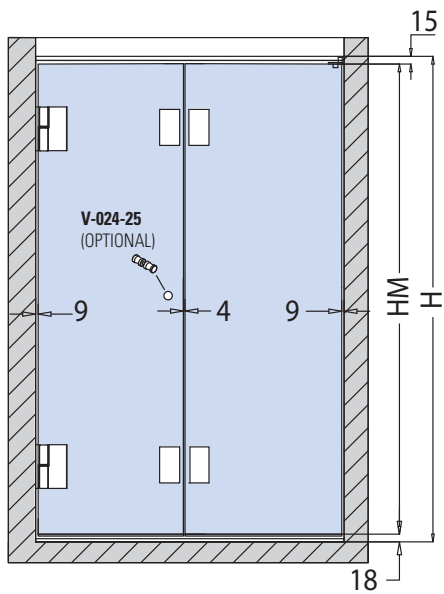

LM tot = LP - 22
LM1 = (LM tot / 2) - 9
LM2 = (LM tot / 2) + 9
HM = H - 33

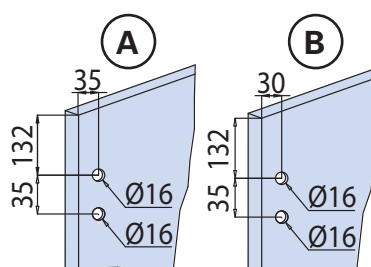
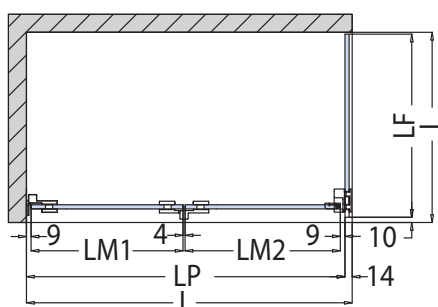
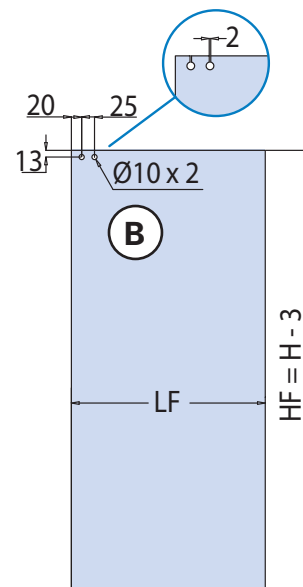
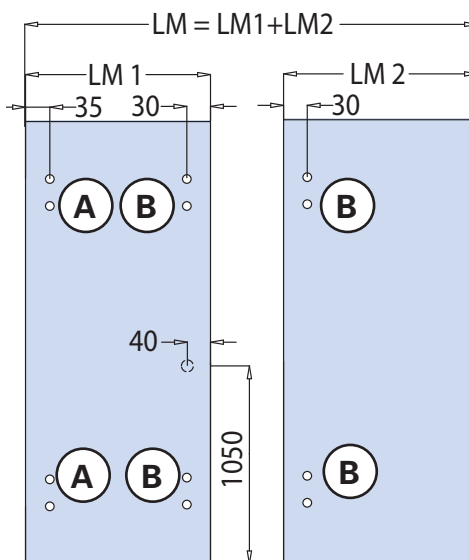
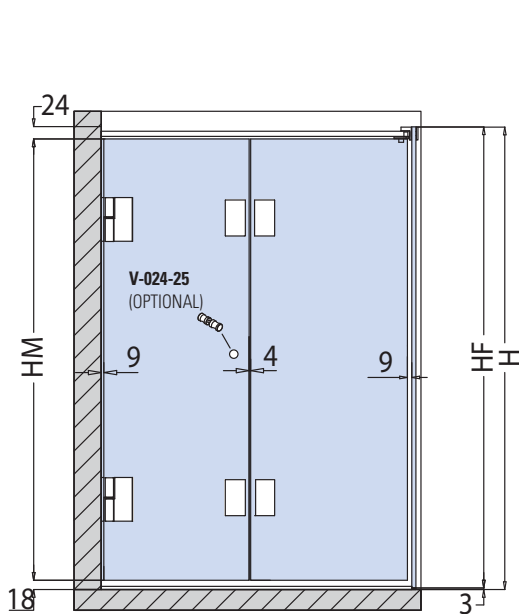

LP = L - 14
LM tot = LP - 22
LM1 = (LM tot / 2) - 9
LM2 = (LM tot / 2) + 9
HM = H - 42
HF = H - 3
LF = L - 10

BX-2600

COMPONENTI | COMPONENTS | EINZELTEILE

BX-2603 DX

- Attacco destro a vetro e attacco a parete
- Right glass connector and wall connector
- Glashalter rechts und Wandhalter

CR

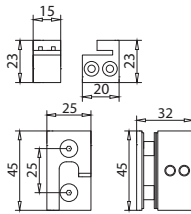

xfb-080

BX-2603 SX

- Attacco sinistro a vetro e attacco a parete
- Left glass connector and wall connector
- Glashalter links und Wandhalter

CR

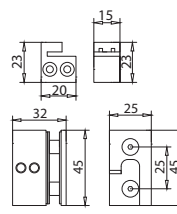

xfb-080

B-147-8

- Guarnizione gocciolatoio in PVC trasparente. Lunghezza barre 2200 mm. Per vetro da 8 mm
- Drip flap seal transparent PVC Bar length is 2200 mm. For 8 mm glass.
- Pvc Dichtprofil für den unteren Wannenschluss für 8 mm oder Glas. Länge 2200 mm.

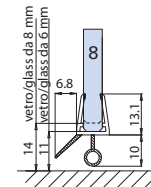

xme318

B-145-8

- Guarnizione a palloncino vetro/muro in PVC trasparente. L = 2200 mm
- Glass to wall ball seal transparent PVC. L = 2200 mm
- PVC Dichtprofil Glas-Wand. L = 2200 mm

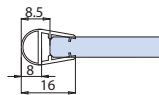

xme390

WRU-S 40/60

- Guarnizione neutra per vetro 8 mm. con fissaggio adesivo.
- Neutral gasket for glass 8 mm. self-adhesive
- Dichtungsprofil für 8 mm. selbstklebend

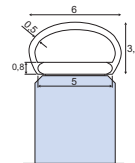

as2 sezione

